

CBT-120 LEDs



Table of Contents

Technology Overview2

Test Specifications2

Bin Codes.....3

Product Shipping & Labeling Information.....4

Optical & Electrical Characteristics5

Flux & Spectral Characteristics vs. Temperature9

Lifetime & Lumen Maintenance.....9

Spectral Characteristics....9

Radiation Patterns 10

Thermal Resistance 10

Mechanical Dimensions .. 11

Ordering Information 12

Features:

- Extremely high optical output: Over 1225 Red Lumens
Over 2000 Green lumens
Over 470 Blue Lumens
- High thermal conductivity package - junction to heat sink thermal resistance of only 0.7 °C/W
- Photonic lattice technology for very high surface brightness and uniform emission
- Large, monolithic chip with surface emitting area of 12 mm²
- High luminous efficacy
- Lumen maintenance of greater than 70% after 60,000 hours
- Environmentally friendly: RoHS compliant
- Variable drive currents: less than 1 A through 30 A
- Currently available in Red, Green and Blue; other colors to follow

Applications

- Entertainment
- Architectural Lighting
- Medical Lighting
- Spot Lighting
- Fiber Coupled Illumination
- Emergency Vehicle Lighting
- Machine Vision
- Projection Systems
- Displays and Signage
- General Illumination

Technology Overview

Luminus Big Chip LEDs™ benefit from a suite of innovations in the fields of chip technology, packaging and thermal management. These breakthroughs allow illumination engineers and designers to achieve solutions that are high brightness and high efficiency.

Photonic Lattice Technology

Luminus' photonic lattice technology enables large area LED chips with uniform brightness over the entire LED chip surface. The optical power and brightness produced by these large monolithic chips enable solutions which replace arc and halogen lamps where arrays of traditional high power LEDs cannot.

For red, green and blue LEDs, the photonic lattice structures extract more light and create radiation patterns that are more collimated than traditional LEDs. Having higher collimation from the source increases optical collection efficiencies and simplifies optical designs.

Packaging Technology

Thermal management is critical in high power LED applications. With a thermal resistance from junction to heat sink of 0.7° C/W, Luminus CBT-120 LEDs have the lowest thermal resistance of any LED on the market. This allows the LED to be driven at higher current densities while maintaining a low junction temperature, thereby resulting in brighter solutions and longer lifetimes.

Reliability

Designed from the ground up, Luminus Big Chip LEDs are one of the most reliable light sources in the world today. Big Chip LEDs have passed a rigorous suite of environmental and mechanical stress tests, including mechanical shock, vibration, temperature cycling and humidity, and have been fully qualified for use in extreme high power and high current applications. With very low failure rates and median lifetimes that typically exceed 60,000 hours, Luminus Big Chip LEDs are ready for even the most demanding applications.

Environmental Benefits

Luminus LEDs help reduce power consumption and the amount of hazardous waste entering the environment. All Big Chip LED products manufactured by Luminus are RoHS compliant and free of hazardous materials, including lead and mercury.

Understanding Big Chip LED Test Specifications

Every Luminus LED is fully tested to ensure that it meets the high quality standards expected from Luminus' products.

Testing Temperature

Luminus core board products are typically measured in such a way that the characteristics reported agree with how the devices will actually perform when incorporated into a system. This measurement is accomplished by mounting the devices on a 40°C heat sink and allowing the device to reach thermal equilibrium while fully powered. Only after the device reaches equilibrium are the measurements taken. This method of measurement ensures that Luminus Big Chip LEDs perform in the field just as they are specified.

Multiple Operating Points (4.2 A, 18 A, 30 A)

The tables on the following pages provide typical optical and electrical characteristics. Since the LEDs can be operated over a wide range of drive conditions (currents from <1A to 30 A, and duty cycle from <1% to 100%), multiple drive conditions are listed.

CBT-120 devices are production specified at 18 A. The values shown at 4.2 A and 30 A are for additional reference at other possible drive conditions.

Big Chip CBT-120 RGB Bin Structure

CBT-120 LEDs are specified for luminous flux and chromaticity/wavelength at a drive current of 18 A (1.5 A/mm²) and placed into one of the following luminous flux (FF) and wavelength (WW) bins:

Blue Bins

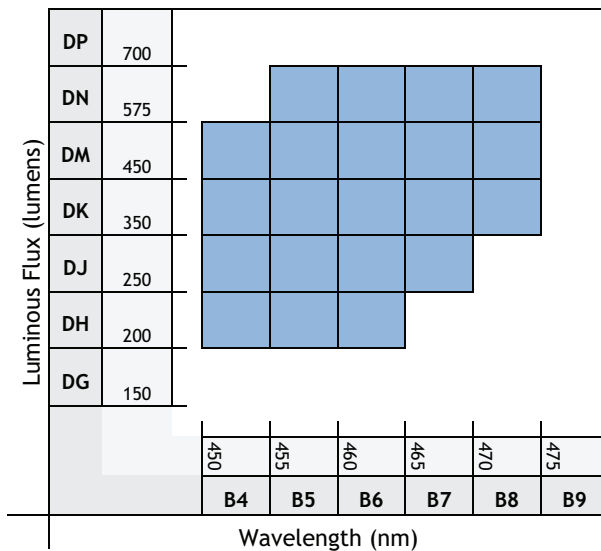

Green Bins

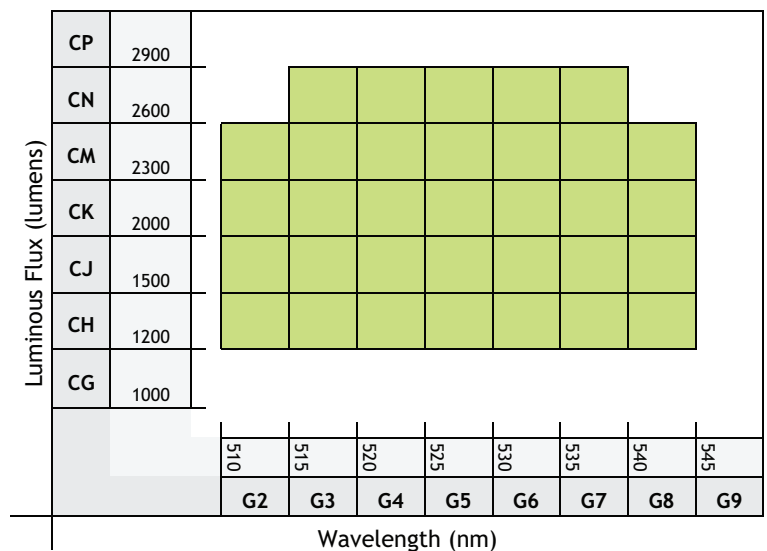

Red Bins

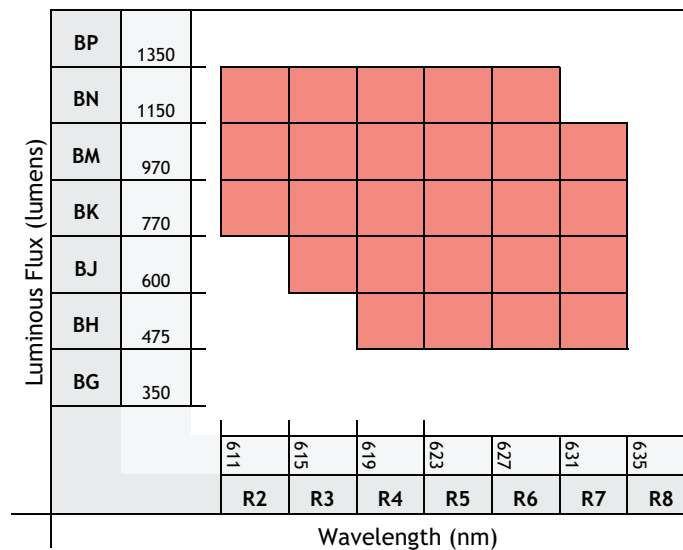

Note 1: Luminus maintains a +/- 6% tolerance on flux measurements.

Note 2: Only specific bins are available, please call Luminus sales team for details.

CBT-120 Shipping & Labeling Information

All CBT-120 products are packaged and labeled with their respective bin as outlined in the tables on page 3. When shipped, each package will only contain one bin. The part number designation is as follows:

CBT — 120 — X — C11 — FF — WW

Product Family	Chip Area	Color	Package Configuration	Flux Bin	Wavelength Bin
CBT: Chip on Board	120: 12.0 mm ²	R: Red G: Green B: Blue	C11: 28 x 27 mm board	See page 3 for bins	See page 3 for bins

Note 1: WNNX nomenclature corresponds to the following:

W = White

NN = color temperature, where:

65 corresponds to 6500K

40 corresponds to 4000K

30 corresponds to 3000K, etc.

X = color rendering index, where:

S (standard) corresponds to a typical CRI of 70

M (moderate) corresponds to a typical CRI of 83

H (high) corresponds to a typical CRI of 92

Note 2: Some flux and wavelength bins may have limited availability. Application specific bin kits, consisting of multiple bins, may be available. For ordering information, please refer to page 12 and reference the PDS-001393 Binning and Labeling Rev 06 document.

Example:

The part number CBT-120-R-C11-BM-R4 refers to a red, CBT-120 module, with a flux range of 970-1,150 lumens and a wavelength range of 619 nm to 623 nm.

Reference Optical & Electrical Characteristics
 $(T_{\text{heat sink}} = 40^{\circ}\text{C})^0$

Red					
Drive Condition ²		4.2 A Continuous	18 A Continuous	30 A Pulsed 50% D.F. ³	
Parameter	Symbol	Values ⁴			Unit
Current Density	j	0.35	1.5	2.5	A/mm ²
Forward Voltage	$V_{F\text{min}}$		2.0		V
	V_f	1.8	2.3	2.6	V
	$V_{F\text{max}}$		2.6		V
Luminous Flux ⁵	$\Phi_{V\text{typ}}$	190	825	1400	lm
Radiometric Flux	Φ_R	1.3	5.5	8.0	W
Luminous Efficacy	η	26	20	18	lm/W
Dominant Wavelength ⁶	λ_d	622	623	623	nm
Peak Wavelength	λ_p	625	628	629	nm
Color Saturation	-	1.00	1.00	1.00	-
FWHM	$\Delta\lambda_{1/2}$	16	19	20	nm
Chromaticity Coordinates ^{7,8}	x	0.695	0.699	0.702	-
	y	0.305	0.301	0.298	-

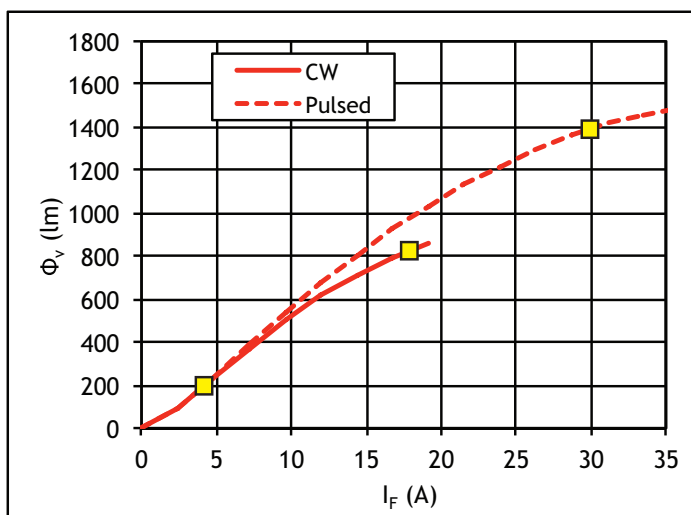
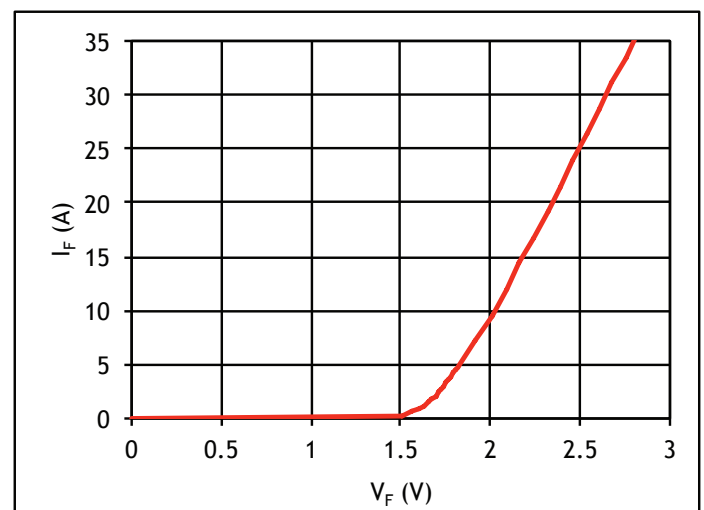
Relative Output Flux vs. Forward Current¹

Forward Current vs. Forward Voltage

Yellow squares indicate reference drive conditions

Notes: See page 8

Reference Optical & Electrical Characteristics
 $(T_{\text{heat sink}} = 40^{\circ}\text{C})^1$

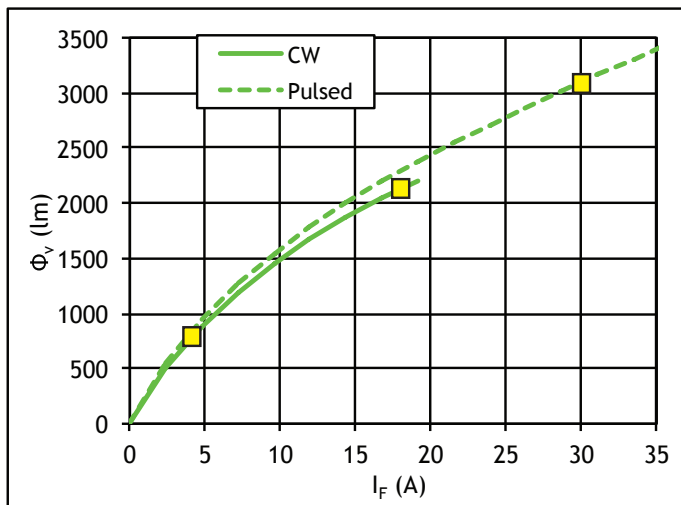
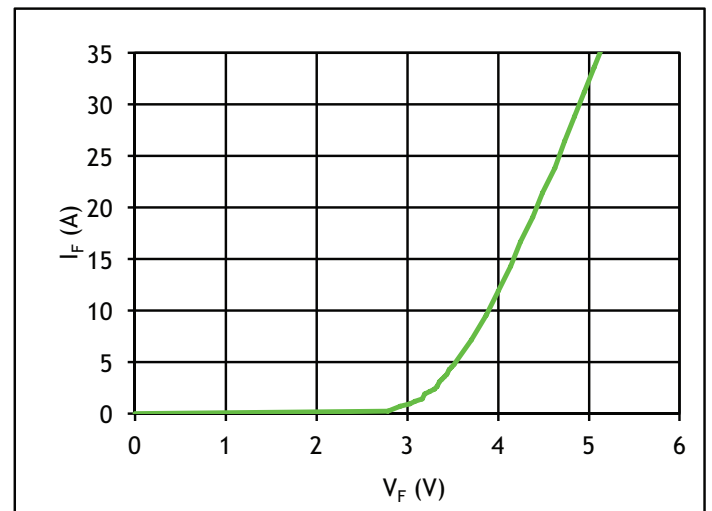
Green					
Drive Condition ²		4.2 A Continuous	18 A Continuous	30 A Pulsed 50% D.F. ³	
Parameter	Symbol	Values ⁴			Unit
Current Density	j	0.35	1.5	2.5	A/mm ²
Forward Voltage	$V_{F \text{ min}}$		3.8		V
	V_f	3.5	4.3	4.9	V
	$V_{F \text{ max}}$		4.9		V
Luminous Flux ⁵	$\Phi_{V \text{ typ}}$	800	2100	3100	lm
Radiometric Flux	Φ_R	1.6	4.1	6.3	W
Luminous Efficacy	η	55	28	21	lm/W
Dominant Wavelength ⁶	λ_d	535	528	521	nm
Peak Wavelength	λ_p	530	524	521	nm
Color Saturation	-	0.91	0.83	0.79	-
FWHM	$\Delta\lambda_{1/2}$	35	39	40	nm
Chromaticity Coordinates ^{7,8}	x	0.205	0.175	0.161	-
	y	0.740	0.730	0.722	-

Relative Output Flux vs. Forward Current¹

Forward Current vs. Forward Voltage

Yellow squares indicate reference drive conditions

Notes: See page 8

Reference Optical & Electrical Characteristics

($T_{\text{heat sink}} = 40^{\circ}\text{C}$)¹

Blue					
Drive Condition ²		4.2 A Continuous	18 A Continuous	30 A Pulsed 50% D.F. ³	
Parameter	Symbol	Values ⁴			Unit
Current Density	j	0.35	1.5	2.5	A/mm ²
Forward Voltage	$V_{F\text{min}}$		3.5		V
	V_f	3.4	4.1	4.5	V
	$V_{F\text{max}}$		5.0		V
Luminous Flux ⁵	$\Phi_{V\text{typ}}$	150	400	600	lm
Radiometric Flux	Φ_R	2.7	7.2	12.3	W
Luminous Efficacy	η	11	6	5	lm/W
Dominant Wavelength ⁶	λ_d	462	462	462	nm
Peak Wavelength	λ_p	459	460	460	nm
Color Saturation	-	0.99	0.99	0.99	-
FWHM	$\Delta\lambda_{1/2}$	22	25	27	nm
Chromaticity Coordinates ^{7,8}	x	0.142	0.142	0.142	-
	y	0.036	0.038	0.038	-

Relative Output Flux vs. Forward Current¹

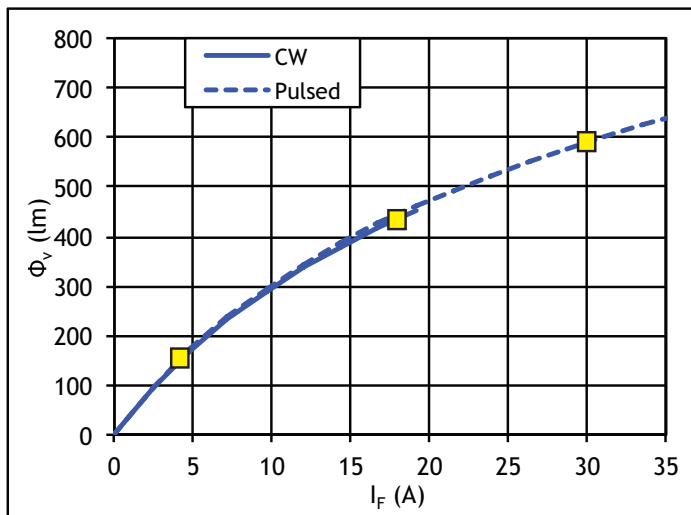

Forward Current vs. Forward Voltage

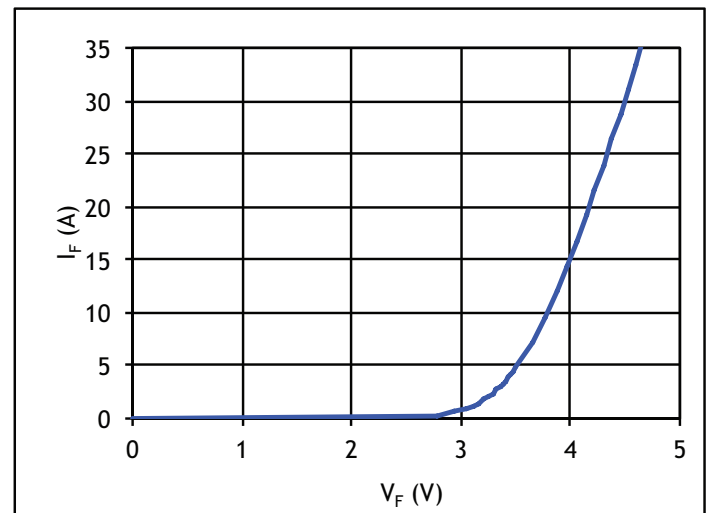

Yellow squares indicate reference drive conditions

Notes: See page 8

Reference Optical and Electrical Characteristics ($T_{\text{heat sink}} = 40^{\circ}\text{C}$)¹
Common Characteristics

	Symbol	Red	Green	Blue	Unit
Emitting Area		12.0	12.0	12.0	mm ²
Emitting Area Dimensions		4.6x2.6	4.6x2.6	4.6x2.6	mmxmm
Dynamic Resistance	Ω_{dyn}	0.03	0.04	0.02	Ω
Thermal Coefficient of Photometric Flux		-0.96	-0.18	-0.007	%/°C
Thermal Coefficient of Radiometric Flux		-0.52	-0.20	-0.17	%/°C
Thermal Coefficient of Junction Voltage		-1.3	-4.6	-3.5	mV/°C

Absolute Maximum Ratings

	Symbol	Red	Green	Blue	Unit
Maximum Current		36	36	36	A
Maximum Junction Temperature	T_{jmax}	125	150	150	°C
Storage Temperature Range		-40/+100	-40/+100	-40/+100	°C

Note 1: All ratings are based on operation with a constant heat sink temperature $T_{\text{hs}} = 40^{\circ}\text{C}$. See Thermal Resistance section for T_{hs} definition.

Note 2: Listed drive conditions are typical for common applications. CBT-120 devices can be driven at currents ranging from <1 A to 30 A and at duty cycles ranging from 1% to 100%. Drive current and duty cycle should be adjusted as necessary to maintain the junction temperature desired to meet application lifetime requirements.

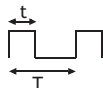
Note 3: Current Density of 2.5 A/mm². Rated at 50% duty cycle and Pulsed operation frequency of $f > 360\text{Hz}$; $DC = \frac{t}{T}$ 

Note 4: Unless otherwise noted, values listed are typical. Devices are production tested and specified at 18 A. Values at 4.2 A and 30 A are for reference only.

Note 5: Total flux from emitting area at listed dominant wavelength. Reported performance is included to show trends for a selected power level. For specific minimum and maximum values, use bin tables. For product roadmap and future performance of devices, contact Luminus.

Note 6: Minimum and Maximum Dominant Wavelengths are based on typical values +/- 5nm for Red, +/- 8nm for Green and +/- 6nm for Blue.

Note 7: In CIE 1931 chromaticity diagram coordinates, normalized to $X+Y+Z=1$.

Note 8: For reference only.

Note 9: CBT-120 LEDs are designed for operation to an absolute maximum current as specified above. Product lifetime data is specified at recommended forward drive currents. Sustained operation at or beyond absolute maximum currents will result in a reduction of device life time compared to recommended forward drive currents. Actual device lifetimes will also depend on junction temperature. Refer to the lifetime derating curves for further information. In pulsed operation, rise time from 10-90% of forward current should be larger than 0.5 microseconds.

Note 10: Lifetime dependent on LED junction temperature. Input power and thermal system must be properly managed to ensure lifetime. See charts on pg 9 for further information.

Note 11: Special design considerations must be observed for operation under 1 A. Please contact Luminus for further information.

Note 12: Caution must be taken not to stare at the light emitted from these LEDs. Under special circumstances, the high intensity could damage the eye.

Light Output and Spectral Characteristics Over Heat Sink Temperature

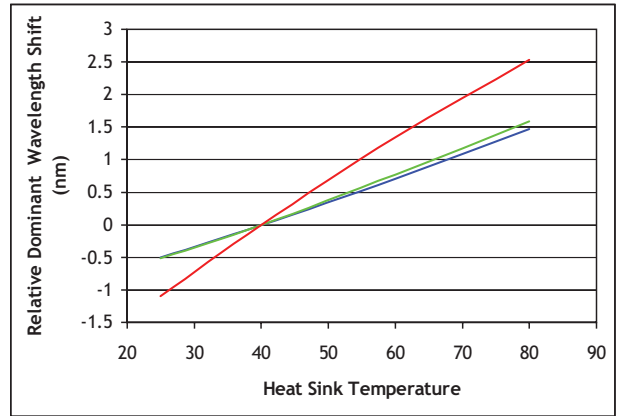
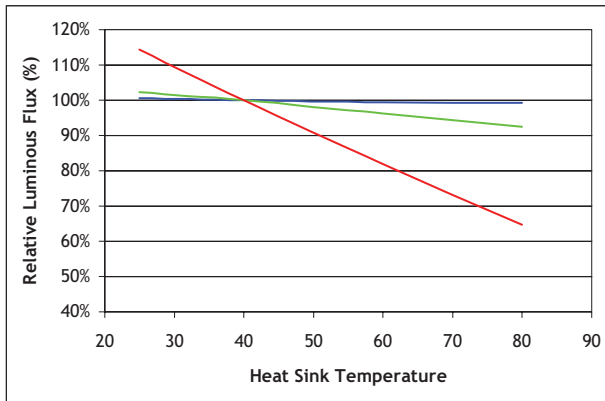

Median Lifetime Estimate vs. Tj¹³

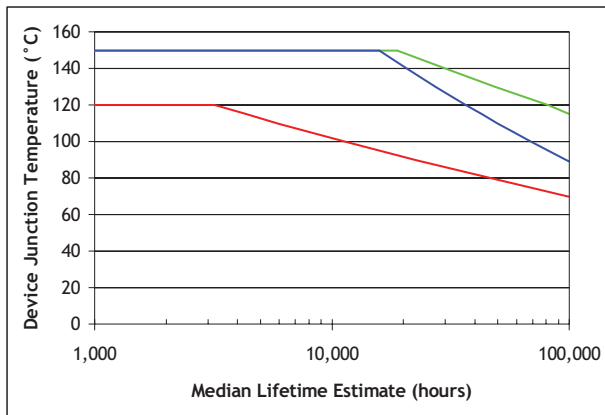

Lumen Maintenance¹⁴

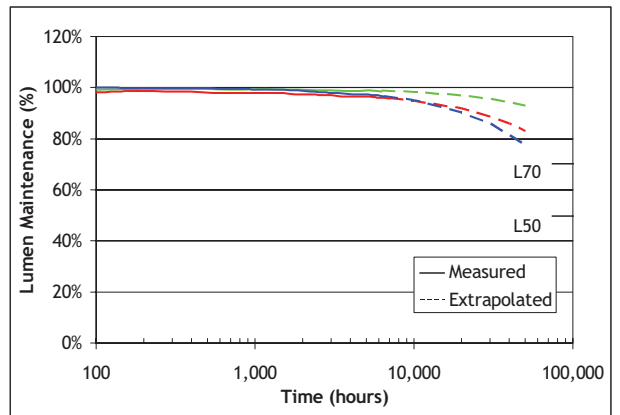

Typical Spectrum¹⁵

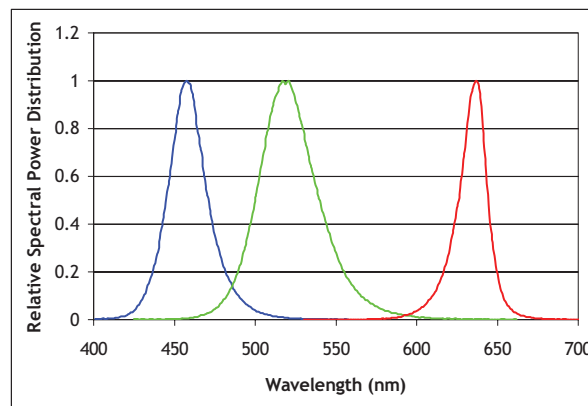

Note 13. Median lifetime estimate as a function of junction temperature at 1.5A/mm² in continuous operation. Lifetime defined as time to 70% of initial intensity. Based on preliminary lifetime test data. Data can be used to model failure rate over typical product lifetime.

Note 14. Lumen maintenance vs. time at 1.5A/mm² in continuous operation, Red junction temperature of 70°C, Green junction temperatures of 120°C, Blue junction temperatures of 100°C.

Note 15. Typical spectrum at current density of 1.5 A/mm² in continuous operation.

Typical Radiation Pattern

Typical Polar Radiation Pattern for Blue and Green

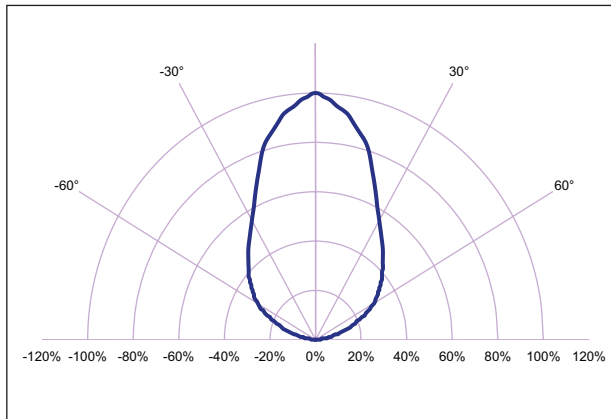

Typical Polar Radiation Pattern for Red

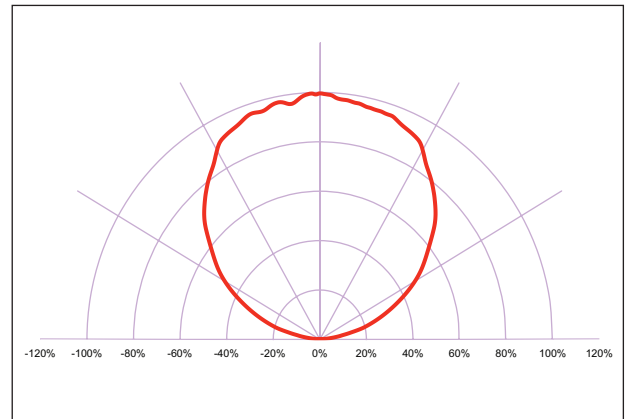

Thermal Resistance

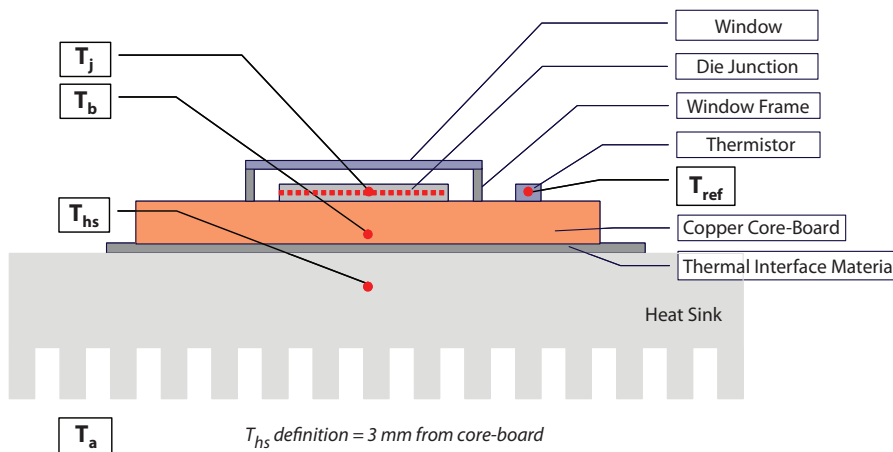

Typical Thermal Resistance

$R_{\theta j-b}^1$	0.61 °C/W
$R_{\theta b-hs}^1$	0.12 °C/W
$R_{\theta j-hs}^2$	0.73 °C/W
$R_{\theta j-ref}^1$	0.64 °C/W

Note 1: Thermal resistance values are based on FEA model results correlated to measured $R_{\theta j-hs}$ data.

Note 2: Thermal Resistance is based on eGraf 1205 Thermal interface.

Thermistor Information

The thermistor used in CBT-120 devices mounted on coreboards is from Murata Manufacturing Co. The global part number is NCP15XH103J03RC. Please see <http://www.murata.com/> for details on calculating thermistor temperature.

For more information on use of the thermistor, please contact Luminus directly.

Electrical Pinout

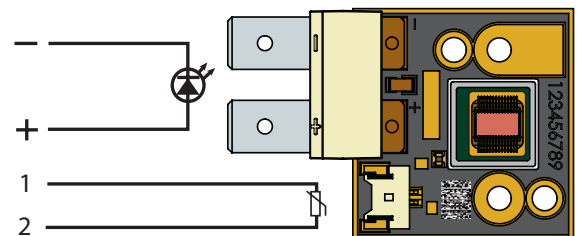

Mechanical Dimensions – CBT-120 RGB Emitter

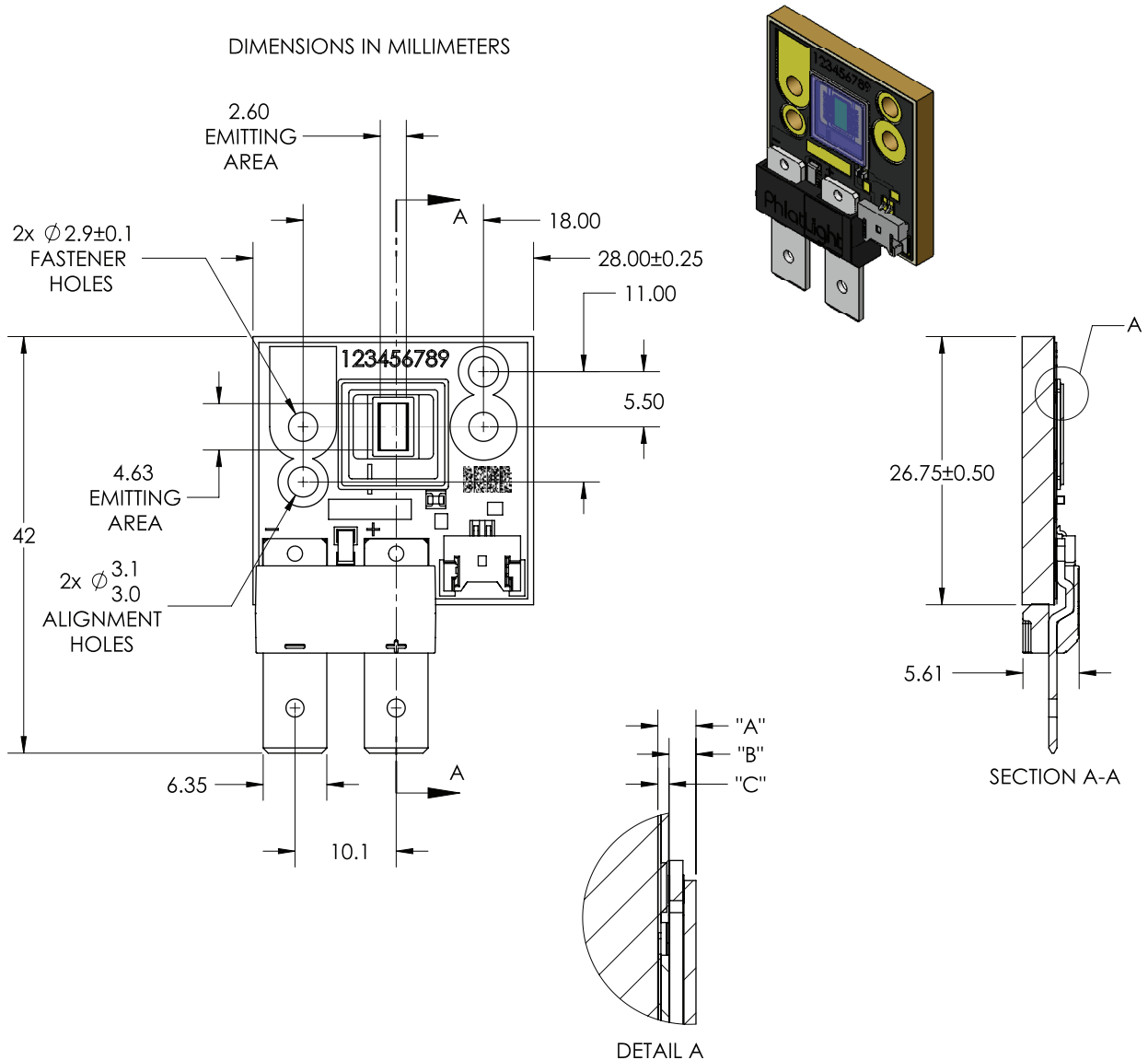

DIMENSION NAME	DESCRIPTION	NOMINAL DIMENSION	TOLERANCE
"A"	TOP OF METAL SUBSTRATE TO TOP OF GLASS	0.95	±0.12
"B"	EMITTING AREA TO TOP OF GLASS	0.67	±0.16
"C"	TOP OF METAL SUBSTRATE TO EMITTING AREA	0.28	±0.05

For detailed drawing of package, please refer to Luminus drawing #DWG-001124.

Recommended connector for Anode and Cathode: Panduit Disco Lok™ Series P/N: DNG14-250FL-C.

Thermistor Connector: MOLEX P/N 53780-0270. Recommended Female: MOLEX P/N 51146-0200 or equivalent.

Ordering Information

Ordering Part Number ^{1,2,3}	Color	Description
CBT-120-R-C11-HH100	Red	Red Big Chip LED™ CBT-120 consisting of a 12 mm ² LED, thermistor, and connector, mounted on a copper-core PCB.
CBT-120-G-C11-JH200	Green	Green Big Chip LED™ CBT-120 consisting of a 12 mm ² LED, thermistor, and connector, mounted on a copper-core PCB.
CBT-120-B-C11-KF300	Blue	Blue Big Chip LED™ CBT-120 consisting of a 12 mm ² LED, thermistor, and connector, mounted on a copper-core PCB.

Note 1: HG100 - denotes a bin kit comprising of all red flux and wavelength bins as specified on page 3.
 JG200 - denotes a bin kit comprising of all green flux and wavelength bins as specified on page 3.
 KF300 - denotes a bin kit comprising of all blue flux and wavelength bins as specified on page 3.
 See PDS-001393 Binning and Labeling Rev 06 document for more information.

Note 2: For info on ordering specific bins or bin ranges, contact your local Luminus sales representative.

Note 3: Standard packaging increment (SPI) is 10.

The products, their specifications and other information appearing in this document are subject to change by Luminus Devices without notice. Luminus Devices assumes no liability for errors that may appear in this document, and no liability otherwise arising from the application or use of the product or information contained herein. None of the information provided herein should be considered to be a representation of the fitness or suitability of the product for any particular application or as any other form of warranty. Luminus Devices' product warranties are limited to only such warranties as accompany a purchase contract or purchase order for such products. Nothing herein is to be construed as constituting an additional warranty. No information contained in this publication may be considered as a waiver by Luminus Devices of any intellectual property rights that Luminus Devices may have in such information. Big Chip LEDs™ is a registered trademark of Luminus Devices, Inc., all rights reserved.

This product is protected by U.S. Patents 6,831,302; 7,074,631; 7,083,993; 7,084,434; 7,098,589; 7,105,861; 7,138,666; 7,166,870; 7,166,871; 7,170,100; 7,196,354; 7,211,831; 7,262,550; 7,274,043; 7,301,271; 7,341,880; 7,344,903; 7,345,416; 7,348,603; 7,388,233; 7,391,059 Patents Pending in the U.S. and other countries.